



Page 17-2

MODULAR TIME RELAYS

- Suitable for modular-slot switchboards
- Selectable time ranges on front:
0.1s...100 days
- LED indication
- Mounting on 35mm DIN rail
- Screw terminals.



Page 17-5

PLUG-IN AND FLUSH-MOUNT TIME RELAYS, 48X48MM

- Flush and internal panel mounting
- Time ranges: 0.05s...10h
- LED indication
- 8 and 11-pin sockets for panel mounting.



- Modular version for modular-slot switchboards, also suitable for rear mounting plate fixing
- Plug-in or flush-mount version
- Vast range of functions and time scales
- Reliable time and repeat accuracy.

Modular version

SEC. - PAGE

On delay. Multiscale. Multivoltage	17 - 2
Multifunction. Multiscale. Multivoltage. 1 relay output	17 - 2
Multifunction. Multiscale. Multivoltage. 2 relay outputs	17 - 3
Recycle, independent timings. Multiscale. Multivoltage	17 - 3
Off delay. Multiscale. Multivoltage	17 - 3
For starting. Multiscale. Multivoltage	17 - 4
For staircase	17 - 4

Plug-in and flush-mount version, 48x48mm/1.9x1.9"

On delay. Multiscale. Multivoltage	17 - 5
On delay. Multiscale. Single voltage	17 - 5
Multifunction. Multiscale. Multivoltage	17 - 5
Accessories	17 - 5

Dimensions	17 - 6
-------------------------	--------

Wiring diagrams	17 - 7
------------------------------	--------

Technical characteristics	17 - 13
--	---------

On delay time relay. Multiscale. Multivoltage



TM P



Order code	Time of scale range	Rated auxiliary supply voltage	Qty per pkg	Wt
		[V]	n°	[kg]
TM P	0.1...1s	24...48VDC	1	0.048
	1...10s 6...60s 1...10min 6min...1h 1...10h 0.1...1 day 1...10 days ON only OFF only	24...240VAC		
TM P A440	0.1...1s 1...10s 6...60s 1...10min	380...440VAC	1	0.090

General characteristics

- Electronic time relay, multiscale, multivoltage.
- On delay, delay on make, with start at relay energising for TM P
- Electronic time relay, multiscale with 2 normally open (N/O-SPST) contacts with common pole for TM P A 440.
- 1 relay output with 1 changeover contact (SPDT)
- Delay time adjustable on front by rotary switch: 10...100%
- Green LED indicator for power on
- Red LED indicator for relay state; flashing for delay and steady when relay energised
- Modular DIN 43880 housing, 1 module
- IEC degree of protection: IP40 on front (only when mounted in housing or electric board with IP40); IP20 on terminals.

Certifications and compliance

Certifications obtained: EAC; UL Listed, for USA and Canada (cULus - File E93601) as Auxiliary Devices - Timers.

Compliant with standards: IEC/EN 61812-1, UL508, CSA C22.2 n° 14.

Operational diagram

See page 17-7.

Multifunction time relay. Multiscale. Multivoltage. 1 relay output



TM M1

Order code	Time of scale range	Rated auxiliary supply voltage	Qty per pkg	Wt
		[V]	n°	[kg]
TM M1	0.1...1s 1...10s 6...60s 1...10min 6min...1h 1...10h 0.1...1 day 1...10 days ON only OFF only	12...240V AC/DC	1	0.086

General characteristics

- Electronic time relay, multifunction, multiscale, multivoltage
- Enabling input
- 1 relay output with 1 changeover contact (SPDT)
- Selectable functions: (a) On delay; delay on make with start at relay energising. (b) Pulse on relay energising with start when energised. (c) Flasher starting with OFF interval. Equal timing recycle. (d) Flasher starting with ON interval. Equal timing recycle. (e) Off delay; relay energising at external contact closing with start on break. (f) Pulse on relay energising with start on external contact closing. (g) Pulse on relay energising with start on external contact opening. (h) On-off delay. Delay on make, with start at external contact closing, and delay at break, with start at external contact opening. (i) Internal ON/OFF trigger with relay contact closing or operating at each closing of an external contact. (j) Pulse generator, unequal timing recycle; starting with OFF pulse time and 0.5s ON pulse.
- Delay time adjustable on front by rotary switch: 10...100%
- Green LED indicator for power on
- Red LED indicator for relay state; flashing for delay and steady when relay energised
- Modular DIN 43880 housing, 1 module suitable for fixing on 35mm DIN rail (IEC/EN 60715)
- IEC degree of protection: IP40 on front (only when mounted in housing or electric board with IP40); IP20 on terminals.

Certifications and compliance

Certifications obtained: EAC; UL Listed, for USA and Canada (cULus - File E93601) as Auxiliary Devices - Timers.

Compliant with standards: IEC/EN 61812-1, UL508, CSA C22.2 n° 14.

Operational diagram

See page 17-7.

Multifunction time relay. Multiscale. Multivoltage. 2 relay outputs



TM M2

Order code	Time of scale range	Rated auxiliary supply voltage	Qty per pkg	Wt
		[V]	n°	[kg]
TM M2	0.1...1s	12...240V AC/DC	1	0.094
	1...10s			
	6...60s			
	1...10min			
	6min...1h			
	1...10h			
	0.1...1 day			
	1...10 days			
	ON only			
	OFF only			

General characteristics

- Electronic time relay, multifunction, multiscale, multivoltage
- Enabling input
- 2 relay outputs, one with 1 delayed changeover (C/O-SPDT) contact and the other with 1 normally open (N/O-SPST) contact, programmable as instantaneous or delayed
- Selectable functions: (a) On delay; delay on make with start at relay energising. (b) Pulse on relay energising with start when energised. (c) Flasher starting with OFF interval. Equal timing recycle. (d) Flasher starting with ON interval. Equal timing recycle. (e) Off delay; relay energising at external contact closing with start on break. (f) Pulse on relay energising with start on external contact closing. (g) Pulse on relay energising with start on external contact opening. (h) On-off delay. Delay on make, with start at external contact closing, and delay at break, with start at external contact opening. (i) Internal ON/OFF trigger with relay contact closing or operating at each closing of an external contact. (j) Pulse generator, unequal timing recycle; starting with OFF pulse time and 0.5s ON pulse.
- Delay time adjustable on front by rotary switch: 10...100%
- Green LED indicator for power on
- Red LED indicator for relay state; flashing for delay and steady when relay energised
- Modular DIN 43880 housing, 1 module suitable for fixing on 35mm DIN rail (IEC/EN 60715)
- IEC degree of protection: IP40 on front (only when mounted in housing or electric board with IP40); IP20 on terminals.

Certifications and compliance

Certifications obtained: EAC; UL Listed, for USA and Canada (cULus - File E93601) as Auxiliary Devices - Timers. Compliant with standards: IEC/EN 61812-1, UL508, CSA C22.2 n° 14.

Operational diagram

See page 17-8.

Recycle time relay, independent timings. Multiscale. Multivoltage



TM PL

Order code	Time of scale range	Rated auxiliary supply voltage	Qty per pkg	Wt
		[V]	n°	[kg]
TM PL	0.1...1s	12...240V AC/DC	1	0.082
	1...10s			
	6...60s			
	1...10min			
	6min...1h			
	1h...10h			
	0.1...1 day			
	1...10 days			
	3...30 days			
	10...100 days			

General characteristics

- Programmable asymmetrical recycle time relay, multiscale, multivoltage. Flasher with independent timing for ON and OFF intervals
- Enabling input of ON or OFF interval
- 1 relay output with 1 changeover contact (SPDT)
- Delay time for OFF (pause) interval, adjustable on front by rotary switch: 10...100%
- Delay time for ON (work) interval, adjustable on front by rotary switch: 10...100%
- Green LED indicator for power on
- Red LED indicator for relay state; flashing for delay
- Modular DIN 43880 housing, 1 module; suitable for fixing on 35mm DIN rail (IEC/EN 60715)
- IEC degree of protection: IP40 on front (only when mounted in housing or electric board with IP40); IP20 on terminals.

Certifications and compliance

Certifications obtained: EAC; UL Listed, for USA and Canada (cULus - File E93601) as Auxiliary Devices - Timers. Compliant with standards: IEC/EN 61812-1, UL508, CSA C22.2 n° 14.

Operational diagram

See page 17-9.

Off delay time relay. Multiscale. Multivoltage



TM D

Order code	Time of scale range	Rated auxiliary supply voltage	Qty per pkg	Wt
		[V]	n°	[kg]
TM D	0.06...0.6s	24...240V AC/DC	1	0.080
	0.6...6s			
	6...60s			
	18...180s			

General characteristics

- Electronic time relay, multiscale, multivoltage. True off delay; delay on break with start at relay de-energising
- 1 relay output with 1 changeover contact (SPDT)
- Delay time adjustable on front by rotary switch: 10...100%
- Green LED indicator for power on
- Modular DIN 43880 housing, 1 module; suitable for fixing on 35mm DIN rail (IEC/EN 60715)
- IEC degree of protection: IP40 on front (only when mounted in housing or electric board with IP40); IP20 on terminals.

Certifications and compliance

Certifications obtained: EAC; UL Listed, for USA and Canada (cULus - File E93601) as Auxiliary Devices - Timers. Compliant with standards: IEC/EN 61812-1, UL508, CSA C22.2 n° 14.

Operational diagram

See page 17-9.

Time relay for starting. Multiscale. Multivoltage



TM ST

Order code	Time of scale range	Rated auxiliary supply voltage	Qty per pkg	Wt
		[V]	n°	[kg]
TM ST	0.1...1s	24...48VDC	1	0.090
	1...10s	24...240VAC		
	6...60s			
	1...10min			
TM ST A440	0.1...1s	380...440VAC	1	0.090
	1...10s			
	6...60s			
	1...10min			

General characteristics

- Electronic time relay, multiscale, multivoltage for starting (star-delta, impedance, autotransformer, etc) of induction motors (squirrel cage), 2 separate timings
- 1 relay output with 2 normally open (N/O-SPST) contacts with common pole
- Delay time adjustable on front by rotary switch: 10-100% for star connection
- Starting and transition (20...300ms time scale - from star to delta), time adjustable on front by rotary switch
- Green LED indicator for power on
- Red LED indicator for relay state; flashing during delay and steady at delay lapsing
- Modular DIN 43880 housing, 1 module; suitable for fixing on 35mm DIN rail (IEC/EN 60715)
- IEC degree of protection: IP40 on front (only when mounted in housing or electric board with IP40); IP20 on terminals.

Certifications and compliance

Certifications obtained: EAC; UL Listed, for USA and Canada (cULus - File E93601) as Auxiliary Devices - Timers. Compliant with standards: IEC/EN 61812-1, UL508, CSA C22.2 n° 14.

Operational diagram

See page 17-10.

Time relay for staircase



TM LS

Order code	Time of scale range	Rated auxiliary supply voltage	Qty per pkg	Wt
		[V]	n°	[kg]
TM LS	0.5...20min	220...240VAC	1	0.080

General characteristics

- Electronic time relay single scale and voltage for staircase illumination
- 1 relay output with 1 powered normally open (N/O-SPST) contact
- Delay time adjustable on front by rotary switch
- Suitable for 3 or 4-wire systems
- 1 slide switch for timed or constant lighting operation
- Function for one hour lighting and fast switch off
- Green LED indicator for power on
- Connection with up to 50 light-up switches maximum; ≤ 1mA each
- Modular DIN 43880 housing, 1 module suitable for fixing on 35mm DIN rail (IEC/EN 60715)
- IEC degree of protection: IP40 on front (only when mounted in housing or electric board with IP40); IP20 on terminals.

Certifications and compliance

Certifications obtained: EAC; UL Listed, for USA and Canada (cULus - File E93601) as Auxiliary Devices - Timers. Compliant with standards: IEC/EN 61812-1, UL508, CSA C22.2 n° 14.

Operational diagram

See page 17-10.

Time relay



31 L48TP...



31 L48TPB...



31 L48M...

Order code	Time scale range	Rated auxiliary supply voltage	Qty per pkg	Wt
		[V]	n°	[kg]

Time relay on delay.
Multiscale and multivoltage.

31 L48TP S 240	0.3...780s	24VAC/DC 110VAC	1	0.124
31 L48TP M 240	18s...780min	220...240VAC	1	0.124

Time relay on delay.
Multiscale and single voltage.

31 L48TPB M24	0.05s...10min	24VAC/DC	1	0.124
31 L48TPB M240		220...240VAC	1	0.124

Time relay, multifunction, multivoltage and multiscale.

31 L48M M 240	0.05s...10min	24...240V AC/DC	1	0.135
31 L48M H 240	0.05min...10h		1	0.135

Accessories for 48x48mm time relay



31 S8



31 S11

Order code	Description	Qty per pkg	Wt
		n°	[kg]
31 S8	8-pin socket for screw fixing or on 35mm DIN rail (IEC/EN 60715). Screw terminals	10	0.061
31 L48 P8	8-pin loose socket. Screw terminals	10	0.040
31 S11	11-pin socket for screw fixing or on 35mm DIN rail (IEC/EN 60715). Screw terminals	10	0.064
31 L48 P11	11-pin loose socket. Screw terminals	10	0.048
31 L48AP	Flush mount bracket	10	0.012

N.B. Max. conductor section for sockets: 2x2.5mm²/2x14AWG.
Tightening torque: 0.8Nm/7.1lbin.

General characteristics

TIME RELAY L48TP

- Electronic time relay, multiscale, multivoltage.
- On delay, delay on make with start at relay energising
- 1 relay output with 1 changeover contact (SPDT)
- Delay time adjustable on front by rotary knob
- Time range selected by dip switches:
L48TP S: 0.3...3s; 1.2...12s; 10...100s; 7.8...780s.
L48 TP M: 18s...3min; 72s...12min; 10...100min; 78...780min
- LED indicators for power on and relay state
- Plug-in housing with 8-pin socket, 31 S8 or 31 L48 P8
- Flush mount bracket 31 L48AP available
- IEC protection degree: IP40 on front and IP20 at terminals.

Time range setting

	A B	A B	A B	A B
L48TP S	0.3...3s	1.2...12s	10...100s	7.8...780s
L48TP M	18s...3min	72s...12min	10...100min	78...780min

TIME RELAY T48TPB

- Electronic time relay, multiscale, single voltage, multifunction
- 2 relay outputs, each with 1 changeover contact (SPDT), configurable either delay on make or instantaneous
- Delay time adjustable on front by rotary knob
- Time range selected by dip switches:
0.05...1s; 0.1...10s; 0.6s...1min; 6s...10min
- LED indicators for power on and relay state
- Plug-in housing with 8-pin socket, 31 S8 or 31 L48 P8
- Flush mount bracket 31 L48AP available
- IEC protection degree: IP40 on front and IP20 at terminals.

Time range setting

	A B	A B	A B	A B
L48TPB	0.05...1s	0.1...10s	0.6s...1min	6s...10min

TIME RELAY L48M

- Electronic time relay, multiscale, multivoltage, multifunction
- Selectable functions: On delay, delay on make with start at relay de-energising. On delay, delay on break with start at relay de-energising. Flasher, starting with OFF interval. Flasher, starting with ON interval. Time relay resetting is possible on closing of external contact (R) connected to terminals 7-6. Possible time relay stopping storing elapsed time on closing of external contact (M) connected to terminals 7-5 and then restarting time on its opening. See diagrams on page 17-11
- 2 relay outputs, each with 1 changeover contact; both delayed (SPDT)
- Delay time adjustable on front by rotary knob
- Time range selected by dip switches:
L48M M: 0.05...1s; 0.1...10s; 0.6s...1min; 6s...10min
L48M H: 0.05...1min; 0.1...10min; 0.6min...1h; 1min...10h
- LED indicators for power on and relay state
- Plug-in housing with 11-pin socket, 31 S11 or 31 L48 P11
- Flush mount bracket 31 L48AP available
- IEC protection degree: IP40 on front and IP20 at terminals.

Time range setting

	A B	A B	A B	A B
L48M M	0.05...1s	0.1...10s	0.6s...1min	6s...10min
L48M H	0.05...1min	0.1...10min	0.6min...1h	1min...10h

Certifications and compliance

Certifications obtained: EAC; UL Recognized, for USA and Canada (cULus - File E172189) as Industrial Switches - Timer modules.
Compliant with standards: IEC/EN 61812-1, UL508, CSA C22.2 n° 14.

Operational diagram

See page 17-10 and 17-11.

TIME RELAYS

TM...

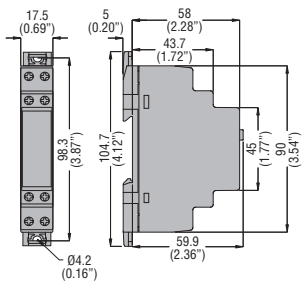

L48...

Cutout

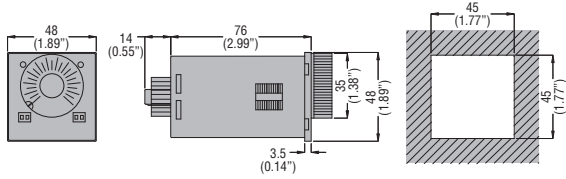

L48... with S8 - S11 sockets

Cutout

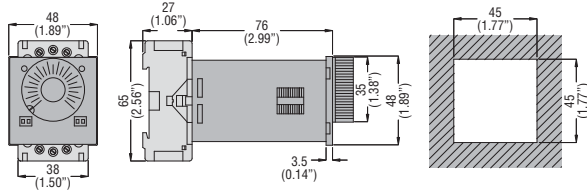

ACCESSORIES - SOCKETS

S8 - S11

L48 P8

L48 P11

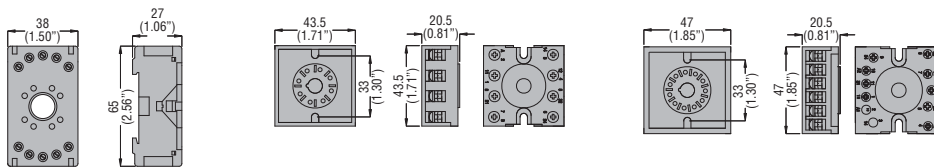

TM P

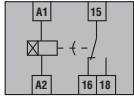

On delay. Delay on make, with start at relay energising.

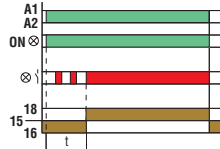

TM P A440

On delay. Delay on make, with start at relay energising.

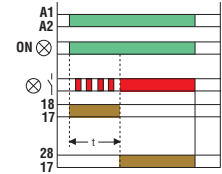
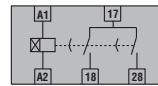

TM M1

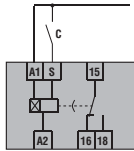

On delay. Delay on make, with start at relay energising

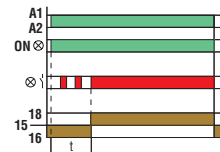

Pulse on relay energising with start at external contact closing

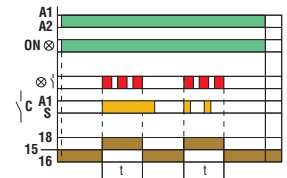

Pulse on relay energising with start on energising

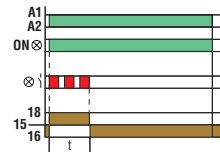

Pulse on relay energising with start at external contact opening

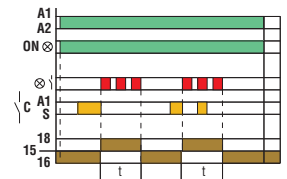

Flasher, starting with OFF (pause) interval. Equal timing recycle.

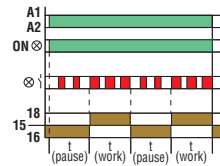

On-Off delay. Delay on make, with start at external contact closing, and delay at break, with start at external contact opening.

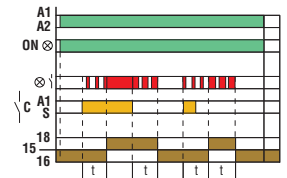

Flasher, starting with ON (work) interval. Equal timing recycle.

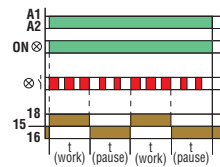

Internal ON/OFF trigger. Relay contact either closes or opens at each external contact closing.

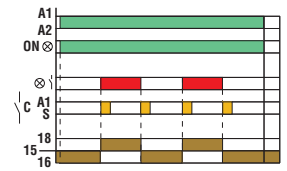

Off delay. Relay energising at external contact closing with start on break

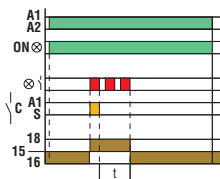

Pulse generator. Unequal timing recycle, starting with OFF pulse time and 0.5sec ON time.

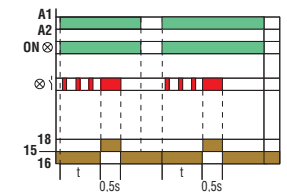

TM M2

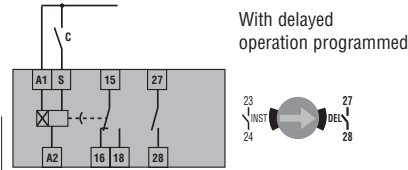
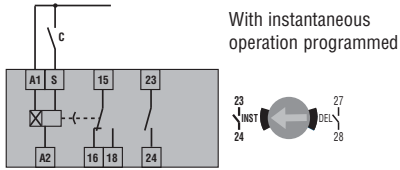

On delay. Delay on make, with start at relay energising

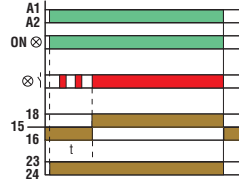

Pulse on relay energising with start on energising

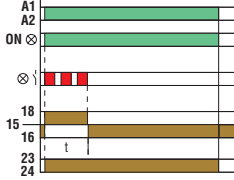

On delay. Delay on make, with start at relay energising

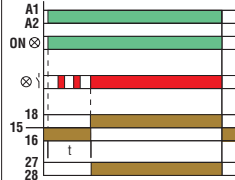

Pulse on relay energising with start on energising

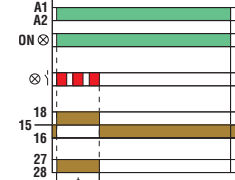

Flasher, starting with OFF (pause) interval. Equal timing recycle

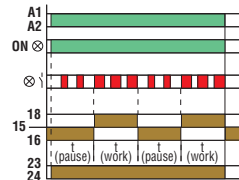

Flasher, starting with ON (work) interval. Equal timing recycle

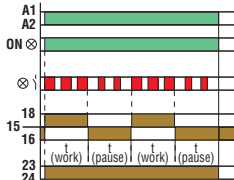

Flasher, starting with OFF (pause) interval. Equal timing recycle

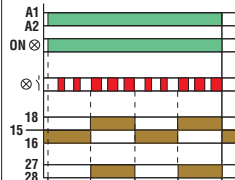

Flasher, starting with ON (work) interval. Equal timing recycle

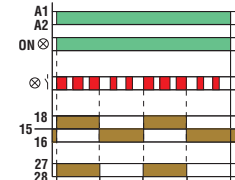

Off delay. Relay energising at external contact closing with start on break

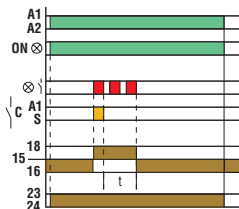

Pulse on relay energising with start on external contact closing

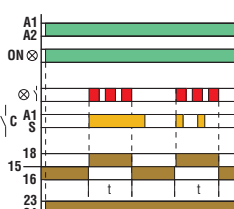

Off delay. Relay energising at external contact closing with start on break

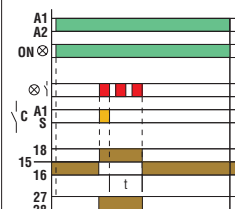

Pulse on relay energising with start on external contact closing

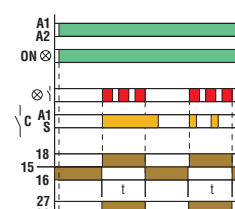

Pulse on relay energising with start on external contact opening

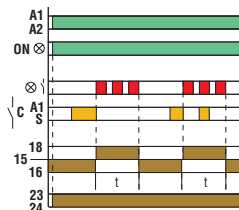

On-off delay. Delay make, with start at external contact closing and delay at break, with start at external contact opening

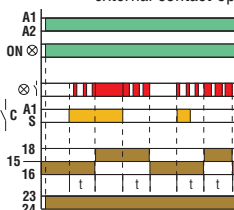

Pulse on relay energising with start on external contact opening

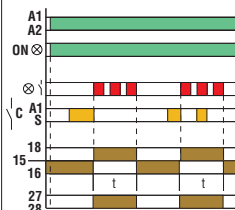

On-off delay. Delay make, with start at external contact closing and delay at break, with start at external contact opening

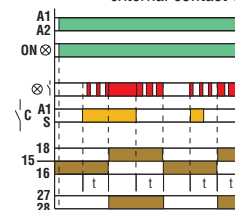

Internal trigger ON/OFF. Relay contact either closes or opens at each external contact closing

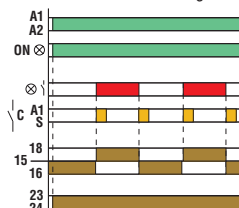

Pulse generator. Unequal timing recycle, starting with ON pulse time

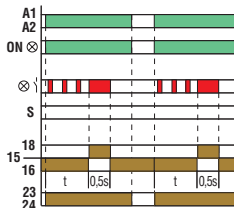

Internal trigger ON/OFF. Relay contact either closes or opens at each external contact closing

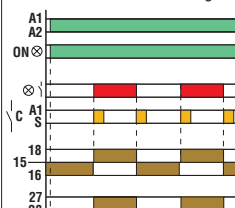

Pulse generator. Unequal timing recycle, starting with ON pulse time

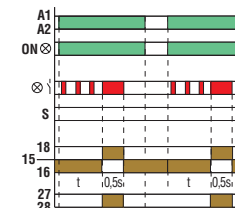

TM PL

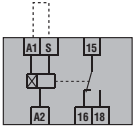

Flasher, starting with ON interval.
Equal timing recycle, ON first

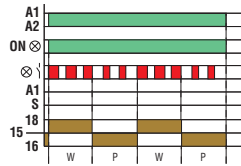

W = Work (ON)
P = Pause (OFF)

Flasher, starting with OFF interval.
Equal timing recycle, OFF first

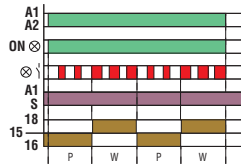

W = Work (ON)
P = Pause (OFF)

TM D

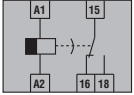

True off delay. Delay on break, starting at
relay de-energising

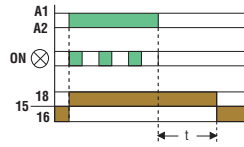

TM ST

For starting

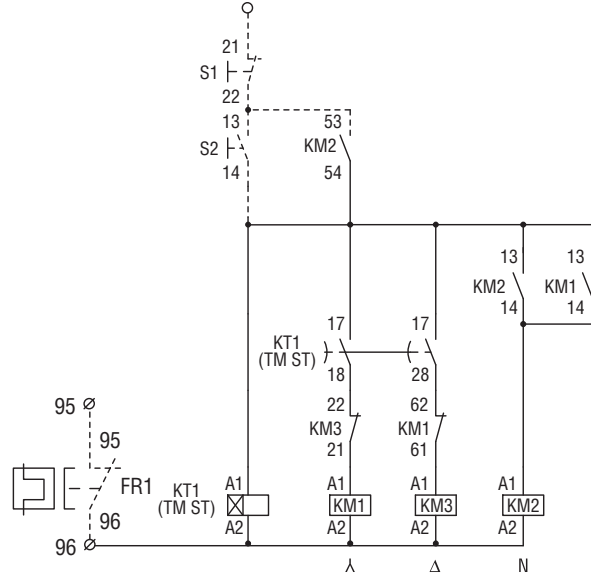
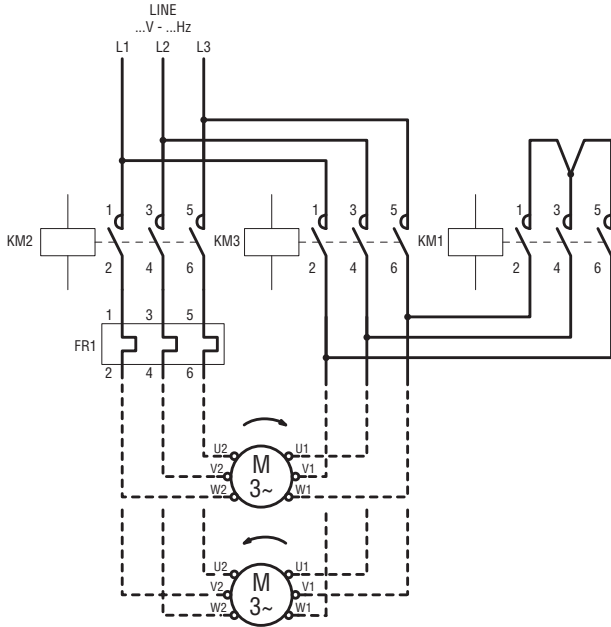
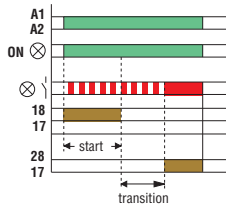
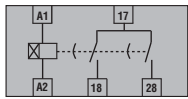

TM LS

Staircase lighting

4-wire connection

3-wire connection

Timed lighting

Constant lighting

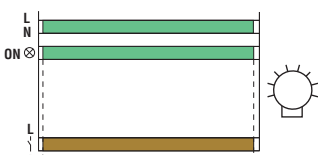
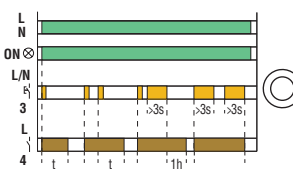
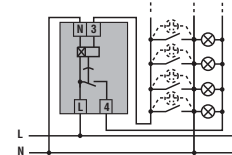
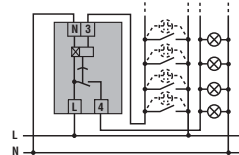

L48TP...

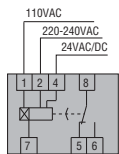

On delay

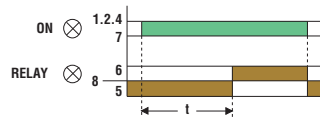

L48TPB...

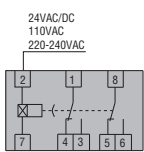

On delay with both instantaneous c/o contacts

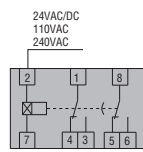
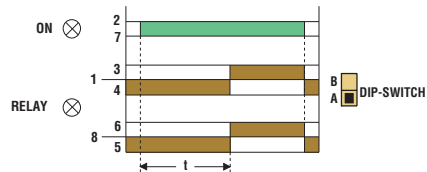

On delay with one instantaneous c/o contact and one late-break c/o contact

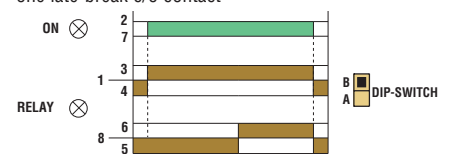

L48M...

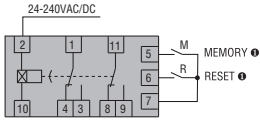

T (preset time) = $T1+T2$

● Contacts "M" and "R" are to be volt free (dry).

On delay

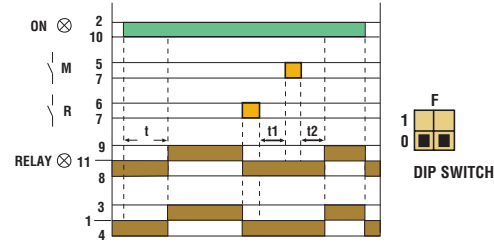

Pulse on relay energising with start on energising

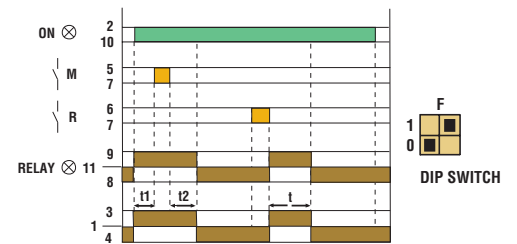

Flasher starting with OFF

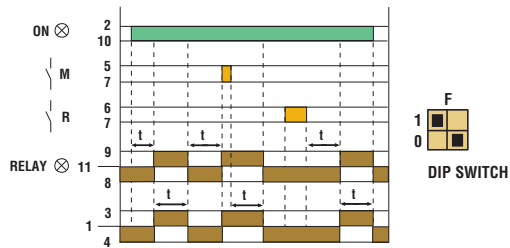

Flasher starting with ON

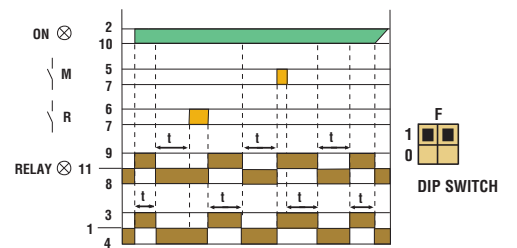

TYPE	TM P	TM P A440	TM M1	TM M2	TM PL	TM D	TM ST	TM LS	
DESCRIPTION	On delay	On delay	Programmable multifunction	Programmable multifunction timing	Asymmetrical recycle	True off delay	For starting	Staircase illumination	
	Multiscale	Multiscale	Multiscale	Multiscale	Multiscale	Multiscale	Multiscale	Single scale	
	Multivoltage	Single voltage	Multivoltage	Multivoltage	Multivoltage	Multivoltage	Multivoltage	Single voltage	
CONTROL CIRCUIT									
Rated auxiliary supply voltage Us	24...48VDC 24...240VAC	380...440VAC	12...240VAC/DC			24...240VAC/DC	24...48VDC 24...240VAC 380...440VAC	220...240VAC	
Rated frequency	50/60Hz								
Operating voltage range	0.85-1.1 Us								
Power consumption (maximum)	1.2VA/0.8W max (24...48VAC/DC) 16VA/0.9W max (110...240VAC/DC)	19VA/1.7W max	0.6VA/0.3W max (12...48VAC/DC) 1.6VA/1.2W max (110...240VAC/DC)	1.1VA/0.8W max (12...48VAC/DC) 1.8VA/1.2W max (110...240VAC/DC)	0.6VA/0.3W max (12...48VAC/DC) 1.6VA/1.2W max (110...240VAC/DC)	0.1VA/0.1W (24...48VAC/DC) 1.1VA/0.8W (110...240VAC/DC)	1.2VA/0.8W max (24...48VAC/DC) 1.6VA/0.9W max (110...240VAC)①	De-energised 5VA/0.5W max Energised 12VA/0.8W max	
TIMING CIRCUIT									
Time setting range	Multiscale 0.1...1s 1...10s 6s...60s 1...10min 6min...1h 1...10h 0.1...1day 1...10days ON only OFF only	Multiscale 0.1...1s 1...10s 6s...60s 1...10min	Multiscale 0.1...1s 1...10s 6s...60s 1...10min 6min...1h 1...10h 0.1...1day 1...10days ON only OFF only	Multiscale 0.1...1s 1...10s 6s...60s 1...10min 6min...1h 1...10h 0.1...1day 1...10days ON only OFF only	Multiscale 0.1...1s 1...10s 6s...60s 1...10min 6min...1h 1...10h 0.1...1day 1...10days ON only OFF only	Multiscale 0.1...1s 1...10s 6s...60s 1...10min 6min...1h 1...10h 0.1...1day 1...10days ON only OFF only	Multiscale 0.06...0.6s 0.6...6s 6s...60s 18s...180s	Multiscale 0.1...1s 1...10s 6s...60s 1...10min	Single scale 0.5...20min
Setting accuracy	< ±9%								
Repeat accuracy	< ±0,1%	< ±0,5%	< ±0,5%	< ±0,2%		< ±0,5%			
Influence of voltage variation	< ±0.01%							< ±0.5%	
Average variation of set delays related to +20°C condition	< ±0.2%							< ±0.25%	
Minimum power time	—	—	—	—	—	≥ 200ms	—	—	
Minimum ON time	—	—	25ms (no maximum limit)			—	—	≥ 60ms (no max lim.)	
Resetting during timing time	≥ 100ms	≥ 100ms	≥ 100ms	≥ 100ms	≥ 100ms	—	≥ 100ms	≥ 100ms	
Resetting elapsed time	≥ 50ms	≥ 50ms	≥ 50ms	≥ 50ms	≥ 50ms	—	≥ 50ms	—	
Immunity time for microbreakings	≤ 50ms	—	≤ 25ms	≤ 15ms	≤ 25ms	—	≤ 40ms②	≤ 20ms	
RELAY OUTPUTS									
Contact arrangement	1 delayed changeover	2 delayed changeover	1 delayed changeover	1 inst./delayed N/O + 1 delayed c/o	1 delayed changeover	1 delayed changeover	2 delayed N/O	1 delayed N/O	
Maximum switching voltage	250VAC								
IEC conventional free air thermal current (Ith)	8A	8A	8A	8A	8A	5A	8A	16A	
UL/CSA and IEC/EN 60947-5-1 designation	B300							16A AC1 240VAC	
Electrical life (with rated load)	10 ⁵ cycles								
Mechanical life	30x10 ⁶ cycles								
Tightening torque maximum	0.8Nm (7lbin; 7...9lbin per UL)								
Conductor section min-max	0.2...4mm ² (24...12 AWG; 12...18 AWG per UL)								
INSULATION (input-output)									
IEC rated insulation voltage	250V								
IEC rated impulse withstand voltage	4kV								
IEC power frequency withstand voltage	2kV								
AMBIENT CONDITIONS									
Operating temperature	-20...+60°C								
Storage temperature	-30...+80°C								
Housing material	Self-extinguishing polyamide								

① For 380...440VAC types: 19VA/1.7W max.

② Used at 24...48VDC or 24...240VAC; ≤30ms at 380...440VAC.

NOTE: N/O = normally open / SPST

c/o = changeover / SPDT; inst. = instantaneous.

Time relays

Technical characteristics

Plug-in and flush mount version 48x48mm/1.9x1.9"

TYPE	L48TP...	L48TPB...	L48M...
DESCRIPTION			
	On delay	On delay	Programmable multifunction
	Multiscale	Multiscale	Multiscale
	Multivoltage	Single voltage	Multivoltage
CONTROL CIRCUIT			
Rated supply voltage U_s	24VAC/DC❶	24VAC/DC❶	24...240VAC/DC❶
	110VAC❶	220...240VAC❶	
	220...240VAC❶		
Rated frequency	50...60Hz		
Operating voltage range	0.85...1.1 U_s		
Power consumption (maximum)	6VA		
Power dissipation (maximum)	⊙		
TIMING CIRCUIT			
Time setting range	Multiscale	Multiscale	Multiscale
	0.3...3s	0.05...1s	0.05...1s
	1.2...12s	0.10...10s	0.1...10s
	10...100s	0.6s...1min	0.6s...1min
	7.8...780s	6s...10min	6s...10min
	18s...3min		0.05...1min
	72s...12min		0.1...10min
	10...100min		0.6min...1h
78...780min		1min...10h	
Setting accuracy	±5%		
Repeat accuracy	±0.5%		
Influence of voltage variation	±0,5%		
Average variation of set delays in related to 20°C condition	at -20°C		+2%
	at +60°C		-3%
Minimum ON time	—		
Resetting time	during operation	≥ 0.1s	≥ 0.1s
	elapsed time	≥ 65ms	≥ 65ms
Immunity time for microbreakings	≤ 40ms	≤ 40ms	≤ 40ms
RELAY OUTPUTS			
Number of relays	1	2	2
Contact arrangement	1 delayed c/o	2 del. or 1 inst. + 1 del. c/o	2 delayed c/o
Maximum switching voltage	250V		
IEC conventional free air thermal current (I_{th})	5A		
UL/CSA and IEC/EN 60947-5-1 designation	B300		
Electrical life (with rated load)	10 ⁵ cycles		
Mechanical life	30x10 ⁶ cycles		
CONNECTIONS			
Tightening torque maximum	—		
Conductor section (min-max)	—		
INSULATION (input-output)			
IEC rated insulation voltage U_i	250V		
IEC power frequency withstand voltage U_{imp}	—		
IEC power frequency withstand voltage	2kV		
AMBIENT CONDITIONS			
Operating temperature	-10...+60°C		
Storage temperature	-30...+80°C		
Housing material	Self-extinguishing polyamide		

❶ Other voltages on request.
 ❷ Consult Customer Service for information; see contact details on inside front cover.
 NOTE:
 del. = delayed inst. = instantaneous c/o = changeover/SPDT